

OPERATOR MANUAL

FOR

MICOM TEL FLN2824
Automatic SSB Telephone
Interconnect (ASTIC)

Revision B

AUGUST 2009

WARNINGS, CAUTIONS AND NOTES

The following notations are used to place special emphasis on procedures, or to call attention to precautionary measures.

WARNING

An operating procedure, practice and so forth, which if not followed correctly, could result in personal injury, or loss of life.

CAUTION

An operating procedure, practice and so forth, which if not followed correctly, could result in damage to, or destruction of equipment.

NOTE

An operating procedure, condition and so forth, to which special attention should be paid.

GENERAL SAFETY PRECAUTIONS



WARNING - HIGH VOLTAGE

High voltages (DC feed and ring) may appear on the telephone line connected to the ASTIC. While installing the ASTIC, avoid touching the exposed pins of the RJ-11 plug when it is not inserted into the ASTIC LINE connector.

Moreover, when the telephone line is not routed exclusively within a building, dangerous voltages may appear on the line during fault conditions, for example, a lightning strike or accidental contact with high-voltage lines. Avoid installing the line during lightning storms.

WARNING

ASTIC is connected to ground via the negative DC power line. This line is normally grounded at the source (always check this before starting). Always connect the ASTIC to the grounded terminal of the DC power source before connecting any other cables.



WARNING - HIGH RF VOLTAGE

When the HF/SSB transceiver connected to the ASTIC transmits, high RF voltages may appear at its RF connectors, on the antenna and antenna feed cable, and on the antenna itself. Avoid touching any parts of the antenna system and RF connectors while the transceiver operates. Make sure that the antenna is not located near high-voltage lines.

Operating and maintenance personnel must be familiar with all the applicable safety requirements before attempting to install or operate the connected HF/SSB transceiver and its antenna system, as presented in the corresponding User's Guide and/or Operator and Installation Manual.

SAFETY SUMMARY

The following are general safety precautions that are not related to any specific procedures and therefore do not appear elsewhere in this publication. These are recommended precautions that personnel must understand and apply during various phases of operation and maintenance.

KEEP AWAY FROM LIVE CIRCUITS. Operating personnel must at all times observe all safety regulations. Do not replace components or make adjustments inside the equipment with the high voltage supply turned on. Under certain conditions, dangerous potentials may exist even when the power control is in the OFF position, due to charges retained by capacitors. To avoid casualties, always remove power and discharge and ground a circuit before touching it.

DO NOT SERVICE OR ADJUST ALONE. Under no circumstances should any person reach into the equipment enclosure for the purpose of servicing or adjusting the equipment except in the presence of someone who is capable of rendering aid.

RESUSCITATION. Personnel working with or near high voltages should be familiar with modern methods of resuscitation.

USE SAFETY APPROVED EQUIPMENT. When cleaners and primers are being applied, approved explosion-proof lights, blowers, and other equipment shall be used. Insure that firefighting equipment is readily available and in working order.

GIVE CLEANERS SPECIAL CARE. Keep cleaners in special polyethylene bottles or in safety cans and in minimum quantities. Discard soiled cleaning cloths into safety cans.

TABLE OF CONTENTS

	Page
CHAPTER 1 GENERAL DESCRIPTION	
1-1. INTRODUCTION	1-1
1-2. PURPOSE AND USE	1-1
1-3. EQUIPMENT DESCRIPTION	1-2
1-3.1 MICOM TEL Unit	1-2
1-3.2 MICOM TEL Accessories	1-2
1-4. TYPICAL APPLICATIONS.....	1-3
1-4.1 Communication between a MICOM-3 Radio User and a Phone Subscriber	1-3
1-4.2 Communication between Two Phone Subscribers via HF Radio	1-4
1-5. TECHNICAL CHARACTERISTICS	1-5
1-5.1 Electrical Characteristics	1-5
1-5.2 General Data	1-5
CHAPTER 2 INSTALLATION AND PREPARATION FOR OPERATION	
2-1. SCOPE	2-1
2-2. FAMILIARIZATION WITH MICOM TEL	2-1
2-3. INSTALLING MICOM TEL	2-1
2-3.1 Connecting MICOM TEL to Ground and Power Source	2-2
2-3.2 Connecting MICOM TEL to the Transceiver	2-2
2-3.3 Connecting MICOM TEL to the Phone Line.....	2-3
2-4. CONFIGURING MICOM TEL	2-3
2-4.1 Preparing for MICOM TEL Configuration	2-4
2-4.2 Configuring MICOM TEL Phone Interface	2-4
2-4.3 Storing MICOM TEL Parameters	2-10
2-4.4 Configuring MICOM TEL Aliases	2-10
2-4.5 Stopping MICOM TEL Operation	2-11
CHAPTER 3 MAKING CALLS	
3-1. SCOPE	3-1
3-2. GENERAL INFORMATION	3-1
3-2.1 General Procedures	3-1
3-2.2 Monitoring the Call.....	3-2
3-3. CALLING A RADIO USER FROM A PHONE.....	3-3
3-4. CALLING A PHONE NUMBER FROM A REMOTE RADIO	3-4
3-5. CALL BETWEEN PHONE SUBSCRIBERS OVER RADIO LINK	3-5
CHAPTER 4 OPERATOR MAINTENANCE	
4-1. SCOPE	4-1
4-2. PREVENTATIVE MAINTENANCE	4-1
4-3. CORRECTIVE MAINTENANCE	4-1
4-4. DISPLAYING THE MICOM TEL HARDWARE AND SOFTWARE VERSIONS.....	4-2

LIST OF ILLUSTRATIONS

	Page
Figure 1-1. MICOM TEL, General View	1-2
Figure 1-2. Providing Communication between Radio Users and Phone Subscribers	1-3
Figure 1-3. Providing Communication between Phone Subscribers over HF Radio Links.....	1-4
Figure 2-1. ASTIC Front Panel.....	2-1
Figure 2-2. ASTIC Rear Panel	2-1
Figure 2-3. DC Power Cable, HKN4137A.....	2-2
Figure 2-4. Structure of UTIL > ASTC Submenu.....	2-3

LIST OF TABLES

	Page
Table 3-1. Signaling Tone Description.....	3-2

CHAPTER 1

GENERAL DESCRIPTION

1-1. INTRODUCTION

This manual covers the MICOM TEL FLN2824 Automatic SSB Telephone Interconnect (ASTIC), intended for use with MICOM-3 HF-SSB radio sets. The manual presents MICOM TEL main features, and provides instructions regarding installation, configuration (programming), calling procedures, and operator maintenance.

The manual is organized as follows:

- Chapter 1 General Description:** provides a general description of the MICOM TEL, and presents its main technical characteristics.
- Chapter 2 Installation and Preparation for Operation:** provides instructions for installing and configuring the MICOM TEL.
- Chapter 3 Making Calls:** explains how to make calls by means of the MICOM TEL.
- Chapter 4 Operator Maintenance:** provides operator maintenance instructions.

The current version of the MICOM TEL is intended for use with MICOM-3 HF-SSB radio sets (for details on versions compatible with MICOM-2, contact manufacturer or your local distributor).

For a description of MICOM-3 HF-SSB radio sets, refer to the “MICOM-3F/3T/3R HF-SSB Transceivers Owner’s Guide”, Publication 6886867J01, and to the Owner’s Guide Supplements.

1-2. PURPOSE AND USE

MICOM TEL provides a seamless, simple and convenient way for integrating long-range HF-SSB voice communication systems (based on MICOM-3 radio equipment operating in the ALE mode) with public switched telephone networks and private phone networks (PABX).

MICOM TEL has a standard telephone interface, similar to that of standard telephone sets, and therefore it can be connected to any standard phone line (for example, to a PSTN line, or to a PABX line). The only technical arrangement needed to connect a MICOM TEL to a phone network is to assign a directory number, as required by any phone set.

Attaching a MICOM TEL unit to a MICOM-3 radio set enables any remote radio user in the same ALE net to call a desired phone subscriber, and vice versa: phone subscribers can dial up the MICOM TEL unit to communicate with a desired remote radio set user.

Moreover, MICOM-3 radio sets equipped with MICOM TEL units enable extending the phone service over long-range HF links. This capability can be used to make phone services available in any location that can be reached by HF-SSB radio, an important capability for multinational organizations, and in emergencies, where phone service may not be available.

1-3. EQUIPMENT DESCRIPTION

1-3.1 MICOM TEL Unit

Figure 1-1 shows a general view of the MICOM TEL unit. MICOM TEL is a compact unit for indoor use, intended for installation on shelves and desktops.



Figure 1-1. MICOM TEL, General View

MICOM TEL connects to the phone line on one side, and to the system connector of a MICOM-3 radio set:

- The phone side interface is a standard FXO (Foreign Exchange Office) interface, the same interface used for analog telephone handsets. FXO is a telephone signaling interface that receives POTS (plain old telephone service). It generates the off-hook and on-hook indications (DC loop closure/non-closure) at the subscriber end of a telephone circuit, is able to accept ringing signals, and to send and receive voice frequency signals. The dialing method is programmable (DTMF or pulse dialing). In addition to being able to dial, the MICOM TEL can also decode incoming dialing, to extract the ALE link call setup commands and data for the MICOM-3 internal control circuits. The phone interface is also used to provide signaling (beeps) that enable the phone subscriber to monitor the call setup process.

The MICOM TEL also includes a VOX (voice-operated switch) signal processor to detect incoming voice activity on the phone line, and to generate the PTT signal for the MICOM-3. Note that the VOX circuit is intended to process only voice signals, and it will not accept fax or voiceband modem signals.

- The connection to MICOM-3 is made by direct connection to the MICOM-3 rear system connector. The system interface uses the MICOM-3 proprietary control protocol to transfer data and control signals between the radio and the MICOM TEL.

There are no operator controls – all the configuration activities needed to prepare MICOM TEL for operation in a specific application are performed at the front panel of the radio set used to provide the HF-SSB link. The configuration parameters are stored in the MICOM TEL, and therefore MICOM TEL services remain available even when the original radio set is replaced.

MICOM TEL requires a DC power source with the same characteristics as that required by MICOM-3 radio sets (13.8 VDC nominal), and has low power consumption.

1-3.2 MICOM TEL Accessories

MICOM TEL is supplied with the following accessories:

- DC power cable, HKN4137A. The cable consists of two sections: the power cable itself, and an extension for the positive (red) lead which includes the fuse housing. The fuse installed in the housing is a 5A/32V fuse.
- Control cable, FKN4639A. This is a 10 ft (3 meter) long cable with a 25-pin male connector at the MICOM-3 side, and 25-pin female connector at the MICOM TEL side. The cable is wired point-to-point.

When connecting to a MICOM-3 radio with 44-pin system connector, a 25-pin/44-pin adapter (Cat. No. 2072-40340-00) must be installed on the transceiver system connector.

A standard RJ-11-to-RJ-11 cable is also needed to connect the MICOM TEL to a standard phone wall jack.

1-4. TYPICAL APPLICATIONS

1-4.1 Communication between a MICOM-3 Radio User and a Phone Subscriber

Figure 1-2 shows a typical corporate system using a MICOM TEL, connected to an extension line of the PABX, to enable communication between remote radio users and phone subscribers served by the PABX. Note that connecting the phone line directly to a PSTN line would enable access from any phone to the radio users, and vice versa.

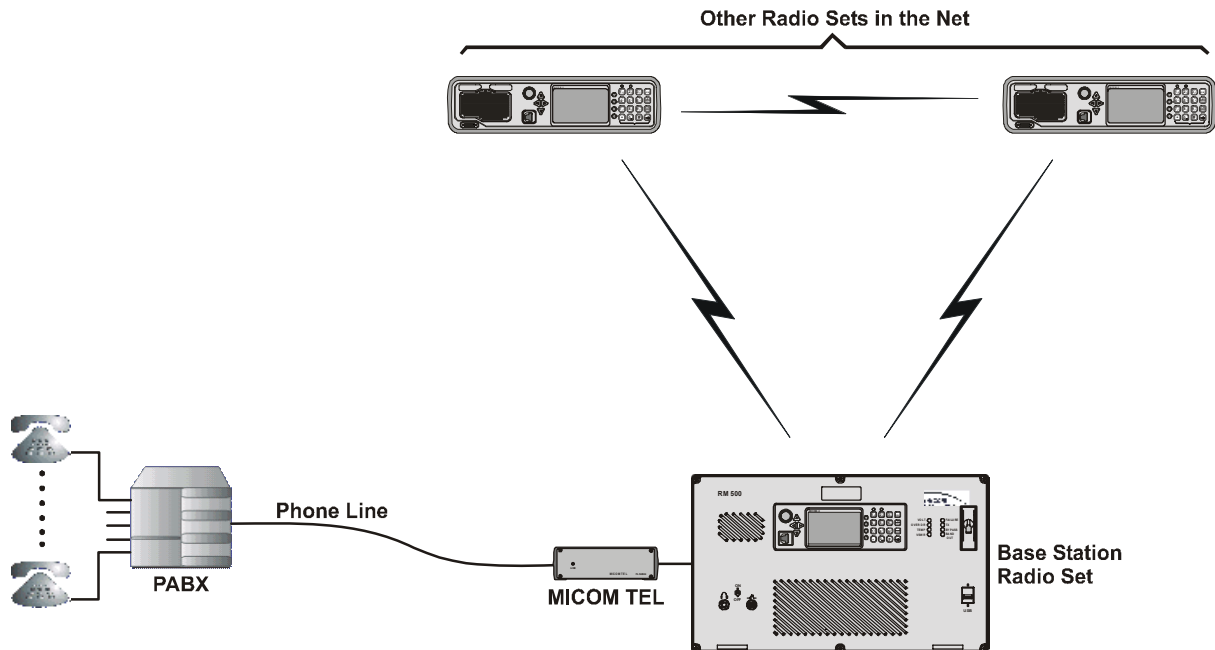

Figure 1-2. Providing Communication between Radio Users and Phone Subscribers

MICOM TEL is usually connected to the MICOM-3 radio in a base station. All the radio sets that need access to phone services must be included in the same ALE net, because the ALE capabilities are used both to direct a call to a specific station, and to reliably set up a good quality link.

Note that for this application, only one radio set in the net must be equipped with a MICOM TEL unit, but this permits only one phone call to be served at a time. Equipping more radio sets in the net with MICOM TEL units permits several users to communicate with phone users at the same time, provided sufficient radio channels are available. Each MICOM TEL must be assigned a unique phone directory number.

- To call a remote radio set from a phone, the subscriber dials the MICOM TEL number, followed by a code (alias) that identifies the destination radio set. Aliases are programmed using the MICOM-3 radio set (a unique alias for each ALE directory entry). MICOM TEL answers the incoming call, decodes the alias, and commands the radio set to set up a link to the specified station. Link set up is automatically performed by the ALE mechanism. After the link is set up, the two parties can communicate using the standard radio procedures (the PTT signal for the phone side is provided by the MICOM TEL VOX circuit).
- To call a phone subscriber from a remote radio set, the remote radio set uses the standard ALE procedure to set up a link to the base station, and sends the phone number to be dialed as an AMD message, using the PAGE function. After the link is set up, MICOM TEL uses the received data to dial the required number to set up a call through the phone network. The communication then proceeds automatically.

1-4.2 Communication between Two Phone Subscribers via HF Radio

Figure 1-3 shows a typical system using MICOM TEL units to extend phone service to remote subscribers over HF radio links. Note that connecting the MICOM TEL to an extension line of the PABX would enable communication with phone subscribers served by the PABX.

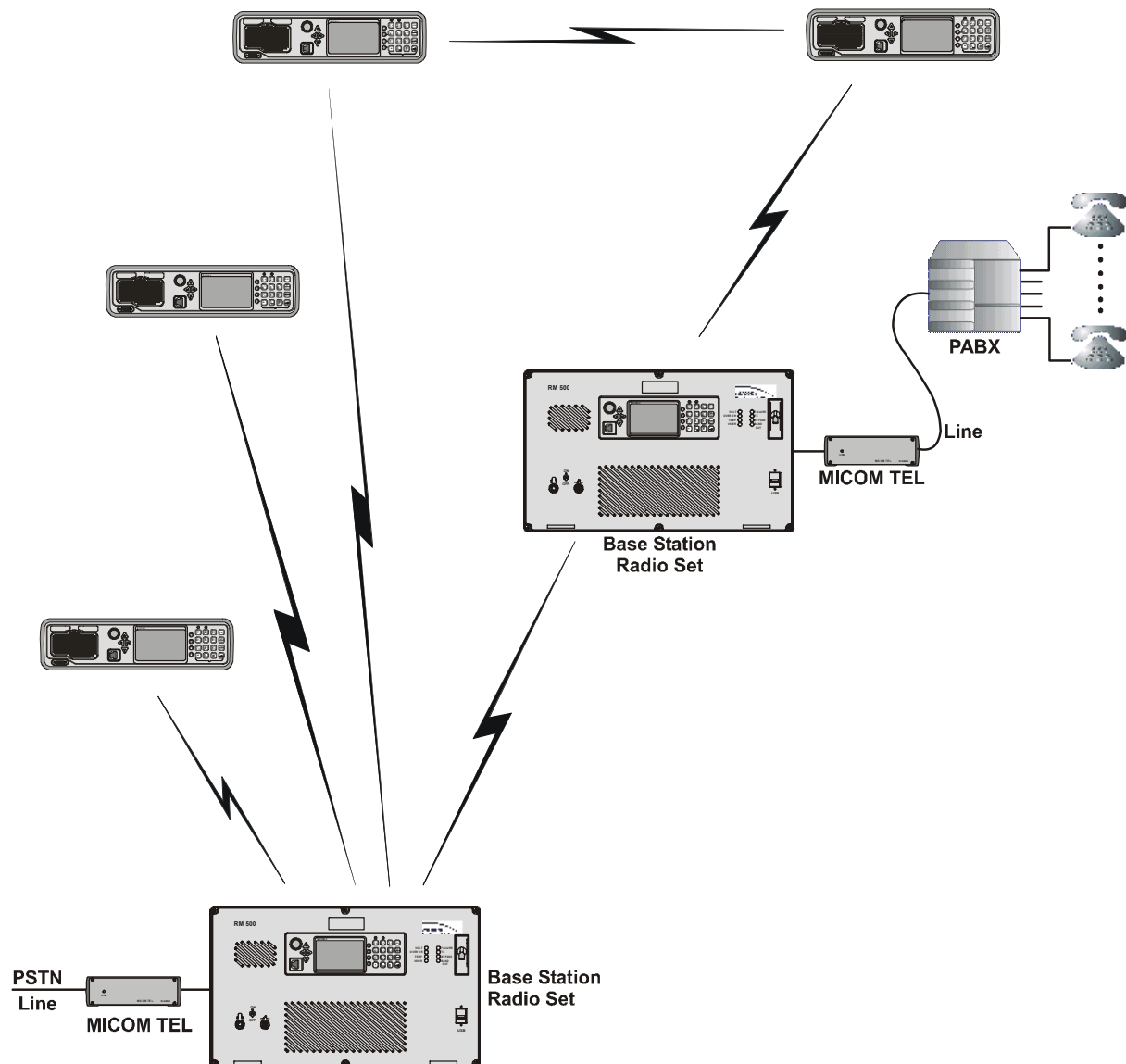

Figure 1-3. Providing Communication between Phone Subscribers over HF Radio Links

To set up a call between remote phone subscribers, a phone subscriber dials the local MICOM TEL number, followed by a code (alias) that identifies the destination radio set, and the phone number to be dialed by the remote MICOM TEL. After the ALE link to the destination station is set up, the remote MICOM TEL dials the number sent by the calling subscriber to set up a call through the remote phone network. The communication then proceeds automatically.

1-5. TECHNICAL CHARACTERISTICS

This section presents the main technical characteristics of MICOM TEL. For complete specifications, contact the manufacturer.

1-5.1 Electrical Characteristics

Radio Interface	25-pin D-type connector, for pin-to-pin connection to MICOM-3 rear panel system connector (via adapter cable)
Audio Characteristics	
Phone line nominal impedance	600 Ω
Input level from phone line	-9 dBm nominal (-25 dBm min)
Output level to phone line	-9 dBm max.
VOX sensitivity (1 kHz)	-25 dBm to -13 dBm (programmable)
Audio distortion	3% max.
Hum and noise	-45 dB max.
Audio frequency response (\pm 3dB)	300 to 3000 Hz (notch on 1024 Hz in SSB receive path)
Ring Input Characteristics	
Ring frequency	TDB to TBD Hz
Sensitivity	TBD VAC min
Ring loading	TBD ren
Phone Line DC Input Characteristics	
DC feed voltage range	TDB to TBD VDC
DC resistance	<ul style="list-style-type: none"> • On-hook: min. TBD kΩ • Off-hook: max. TBD kΩ
Dialing Mode	DTMF (tone) or pulse (programmable)
Telephone Line Connector	RJ-11, accepts 6-position, 4-contact, and 2-contact plugs
Telephone Line Interface Protection	FCC Part 68, DOC CS-03, and UL1459
Power Requirements	
Input voltage range	TDB to TBD VDC (13.8 VDC nominal)
Current consumption	300 mA max. at 13.8 VDC

1-5.2 General Data

Environmental Conditions	
Vibration	MIL-STD-810D Method 514.3 and EIA RS152B
Shock	MIL-STD-810D Method 516.3 and EIA RS152B
Sand & Dust	MIL-STD-810D Method 510.2
Rain	MIL-STD-810D Method 506.2
Salt Fog	MIL-STD-810D Method 509.2
Operating temperature	-22 to +140°F (-30 to +60°C)
Storage temperature	-40 to +185 °F (-40 to +85°C)
Relative humidity	Maximum 95% @ +122°F (+50°C)

Mechanical Data

Dimensions (H × W × L)	2.36" × 6.85" × 10.16" (60 mm × 174 mm × 258 mm)
Weight	3.3 lbs (1.5 kg)

CHAPTER 2

INSTALLATION AND PREPARATION FOR OPERATION

2-1. SCOPE

This Chapter provides instructions for installing and configuring MICOM TEL. The Chapter presents the following information:

- Familiarization with MICOM TEL – para. 2-2.
- Installation procedures – para. 2-3.
- Configuring MICOM TEL – para. 2-4.

2-2. FAMILIARIZATION WITH MICOM TEL

MICOM TEL is a compact unit intended for installation on desktops and shelves. All the connections are made to the rear panel: the front panel includes only one indicator, LINE.

Figure 2-1. ASTIC Front Panel



Figure 2-2. ASTIC Rear Panel

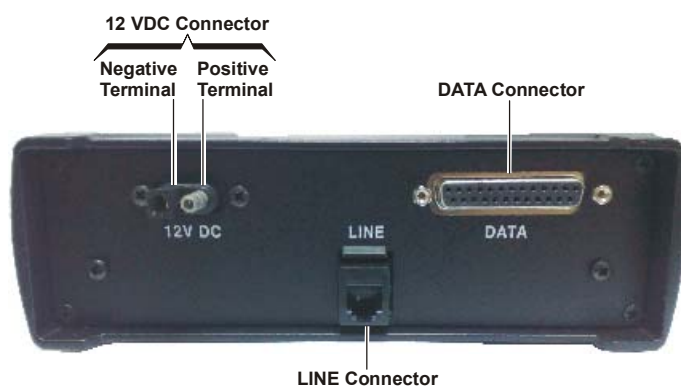

2-3. INSTALLING MICOM TEL

WARNING

Before starting, review the safety precautions presented at the beginning of this manual. MICOM TEL does not have any internal user settings, and therefore do not attempt to open the case.

This section presents instructions for installing MICOM TEL and connecting it to a MICOM-3 transceiver. It is assumed that the transceiver has already been installed, and is ready for operation.

Before starting, select a suitable location for MICOM TEL, considering the length of the cable used to connect to the transceiver, and the length of the DC power cable (both approx. 3 meter/10 ft).

For your safety, connect cables in the order given below.

2-3.1 Connecting MICOM TEL to Ground and Power Source

MICOM TEL is connected to ground by means of the negative lead of the DC power cable. The DC power cable, HKN4137A, consists of two sections, identified in Figure 2-3: the power cable itself, and an extension for the positive (red) lead which includes the fuse housing.

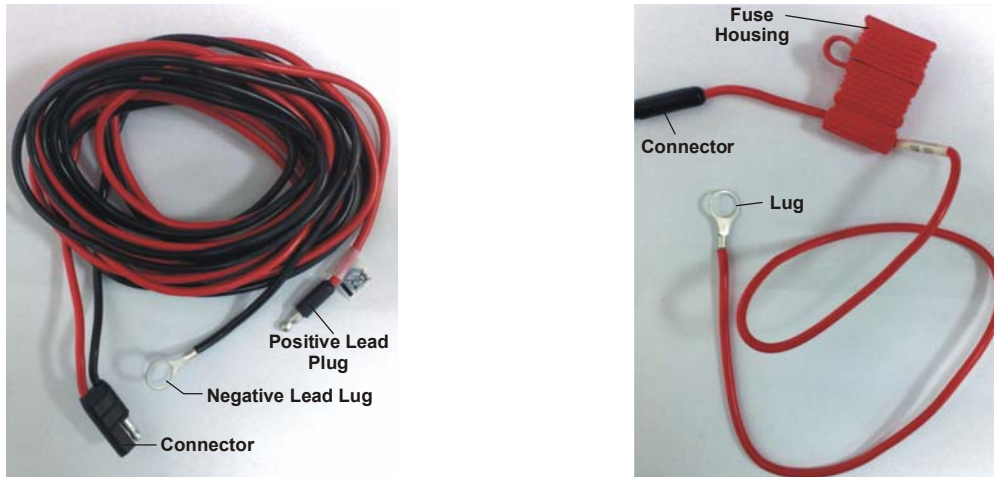

A. Power Cable

B. Fuse Extension Cable

Figure 2-3. DC Power Cable, HKN4137A

1. Connect the lug at the battery end of the negative lead to the negative terminal of a power distribution box, or to the negative battery pole.
2. Connect the lug at the battery end of the extension lead to the positive terminal of a power distribution box, or to the positive battery pole.

CAUTION

MICOM TEL does not have a power ON/OFF switch, and therefore it will start operating as soon as power is applied.

Do not connect DC power until you are ready to start operating the MICOM TEL. Therefore, at this stage, do not connect the extension cable to the power cable.

3. Route the DC power cable to the MICOM TEL, and then plug the cable connector into the 12V DC connector on the MICOM TEL rear panel.

2-3.2 Connecting MICOM TEL to the Transceiver

MICOM TEL connects to the transceiver by means of the control cable FKN4639A.

NOTE

The connection to the transceiver may also be made through a junction box. Contact manufacturer for details.

1. Connect the 25-pin male connector of the control cable to the MICOM TEL DATA connector.

- When connecting the control cable to a MICOM-3 transceiver, install a 25-pin/44-pin adapter (Cat. No. 2072-40340-00), on the transceiver system connector.

This adapter is not needed when connecting to radio sets with 25-pin connectors, for example, RM-125, RM-500, RM-1200, etc.

- Connect the female connector at the other end of the control cable to the transceiver.

2-3.3 Connecting MICOM TEL to the Phone Line

The phone line cable must have a standard RJ-11 plug at the MICOM TEL side.

WARNING

High voltages (for example, DC feed and ringing) may be present on the exposed RJ-11 contacts of the phone cable. Avoid touching the exposed RJ-11 contacts.

Use a standard RJ-11-to-RJ-11 cable when connecting the MICOM TEL to a standard phone wall jack. Always connect the cable first to the MICOM TEL LINE connector, and then to the jack.

At this stage, MICOM TEL is ready for operation.

2-4. CONFIGURING MICOM TEL

MICOM TEL is configured by means of the control panel of the transceiver, provided the transceiver has been ordered with the ASTIC option. When the transceiver detects the connection of an operational MICOM TEL to its system connector, its main menu is modified to include a **UTIL** (utilities) submenu, with **ASTC** (ASTIC) as the only option.

The structure of the submenu is shown in Figure 2-4.

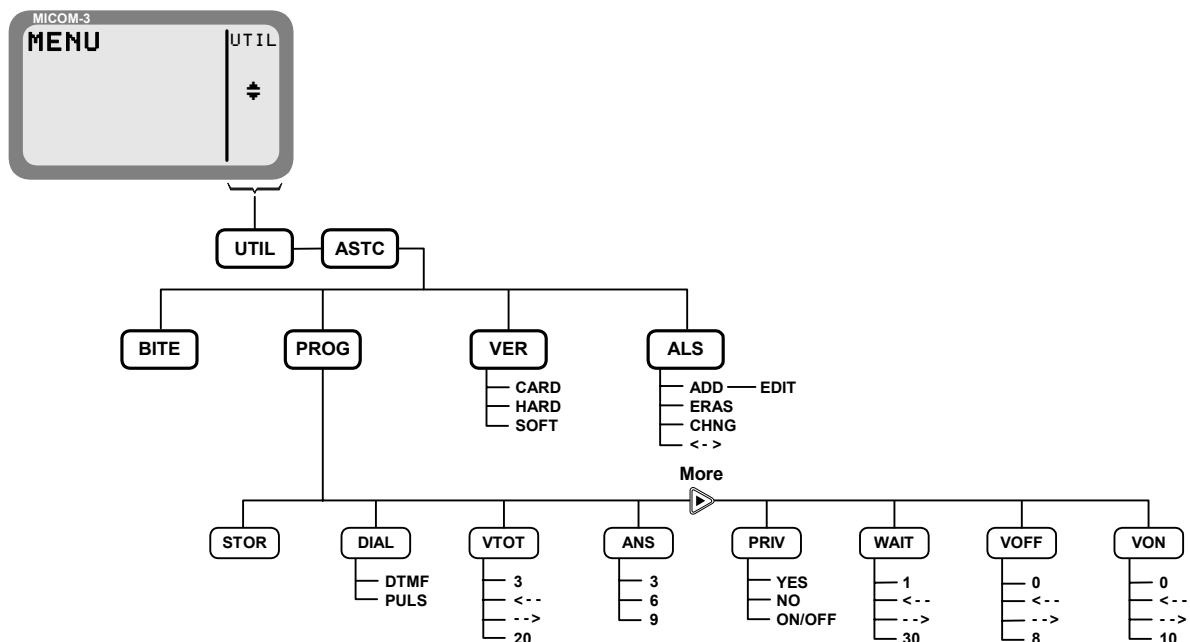

Figure 2-4. Structure of **UTIL > ASTC** Submenu

The ASTC submenu includes the following items:

- BITE** Initiates MICOM TEL self-test. See Chapter 4 for details.
- PROG** Used to configure the phone interface parameters in accordance with your particular application requirements.

- VER** Used to display version information on the various MICOM TEL subsystems. See Chapter 4 for details.
- ALS** Used to configure aliases, needed to enable a remote phone subscriber to call HF-SSB users.

The configuration parameters prepared using the ASTC submenu are stored in the MICOM TEL, and therefore are available even after connecting the MICOM TEL to another transceiver. This can be an advantage when the MICOM TEL must be connected to a different transceiver operating in the same net.

2-4.1 Preparing for MICOM TEL Configuration

To prepare the MICOM TEL for configuration:

1. Make sure that the transceiver ALE parameters and directory have been programmed. To support the MICOM TEL automatic link setup/disconnection, pay attention to the following ALE parameters (configured under **MENU > PROG > ALE > NET > MORE > OPT**):
 - **HACK** (Home Acknowledgment): enable (select **YES**). In this case, the transceiver transmits an end-of-call indication to the remote station.
 - **MACK** (Monitor Acknowledgment): enable (select **YES**). In this case, the transceiver transmits an *accept call* indication to the station that initiated the call.
2. Make sure that you have all the information needed to configure the MICOM TEL.
3. Check that the MICOM TEL has been installed in accordance with para. 2-3.
4. When ready to start configuring the MICOM TEL, connect its power by connecting the plug of the red lead of the DC power cable to the connector of the extension cable (see Figure 2-3 for details).
5. Turn the transceiver off, and then back on. After a few seconds, the transceiver automatically identifies that it is connected to a MICOM TEL.

MICOM TEL is now powered, and you can start its configuration procedure.

2-4.2 Configuring MICOM TEL Phone Interface

NOTE

The following instructions assume that you are familiar with MICOM-3 operation and configuration. If you need more information, refer to the "MICOM-3F/3T/3R HF-SSB Transceivers Owner's Guide", Publication 6886867J01.

To display the ASTC programming menu:

1. Press the **MENU** key to display the first main menu screen.
2. Press **MORE** twice to scroll to the last menu screen.

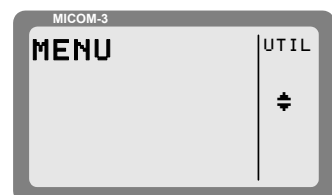

3. Press **UTIL** to display the Utilities menu.

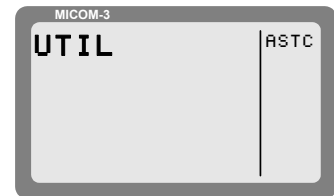

4. Press **ASTC** to display the ASTC submenu.



5. Press **PROG** to display the first screen of the ASTC programming submenu.

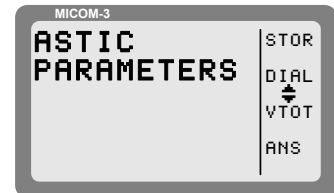

NOTE

You can use the **UP/DOWN** keys to scroll between the menu options, or press the relevant function key to access a particular option.

2-4.2.1 Dialing Method

The MICOM TEL can be configured to use either pulse or DTMF (tone) dialing, to match the dialing method used by the telephony network or PABX to which it is connected.

To select the dialing method:

1. Access the ASTC programming submenu using **MENU > MORE > MORE > UTIL > ASTC > PROG.**

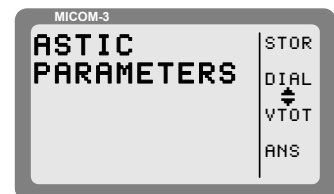

2. Press **DIAL** to display the dialing method selection screen.
The current method is displayed in the second row.

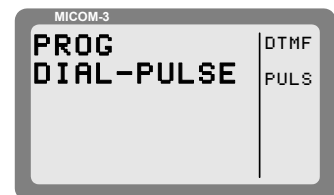

3. Select the desired dialing method:
 - Press **DTMF** for tone dialing.
 - Press **PULS** for pulse dialing.



4. Press **ENTER** to confirm your selection.

2-4.2.2 Voice Operated Switch Time Out

MICOM TEL uses a VOX (voice-operated switch) signal processor to detect incoming voice activity on the phone line, and to generate the PTT signal for the transceiver.

The Voice Operated Switch Time Out Timer (VTOT) parameter determines the time which will elapse from the moment the MICOM TEL detects that there is no activity on the telephone line, until the MICOM TEL automatically disconnects the ALE link. The VTOT range is 3 to 20 minutes.

This mechanism supplements the subscriber-initiated link disconnection command, which is the recommended way to disconnect the link.

Make sure to select a VTOT value smaller than that selected for the PTOT (PTT Timeout) parameter, configured using **MENU > PROG > ALE > OPT**. The PTOT parameter specifies the time (in minutes) which elapses between the moment you release the PTT button, until the transceiver disconnects the ALE link (the allowed range is 1 to 10 minutes). Suitable parameter values are VTOT=3 minutes and PTOT=5 minutes.

To select the VOX time-out interval:

1. Access the MICOM TEL programming submenu using **MENU > MORE > MORE > UTIL > ASTC > PROG**.

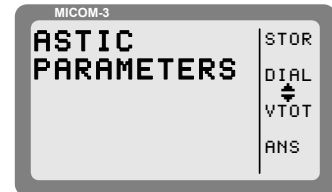

2. Press **VTOT** to display the VTOT configuration screen. The current selection is displayed in the second row.

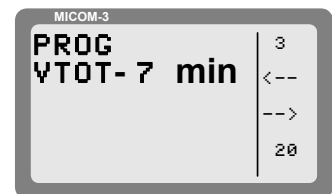

3. Select the prescribed VTOT value:
 - Press **3** to select 3 minutes.
 - Press **20** to select 20 minutes.
 - Press <-- or --> to scroll the VTOT value within the supported range, 3 to 20 minutes.
4. Press **ENTER** to confirm your selection.

2-4.2.3 Answer Ringback Tones

When a remote phone subscriber initiates a call to the MICOM TEL, MICOM TEL detects the ringing received via the phone line, and picks up the call by sending an “off-hook” signal. This parameter specifies the delay (the number of ring cycles) before MICOM TEL picks up the call: 3, 6 or 9 ring cycles.

To select the number of ringback tones:

1. Access the MICOM TEL programming submenu using **MENU > MORE > MORE > UTIL > ASTC > PROG**.

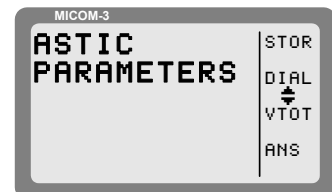

2. Press **ANS** to display the selection screen.

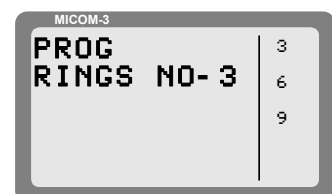

3. Press **3, 6** or **9** to select the desired delay (number of ring cycles).
4. Press **ENTER** to confirm your selection.

2-4.2.4 Private Dial Tone

Phone subscribers connected to internal lines of a PABX must often dial a prefix to get an outside line. In most cases, there is a delay between the dialing of the prefix digit, and the reception performed the second (outside line) dial tone.

When MICOM TEL is connected to an internal PABX line, MICOM TEL can be programmed to wait a certain time after dialing out the first digit (if the dial tone is received between the selected time expires, MICOM TEL will automatically continue the dialing of the remaining digits).

To program the MICOM TEL to wait for a second dialing tone:

1. Access the MICOM TEL programming submenu using **MENU > MORE > MORE > UTIL > ASTC > PROG.**
2. Press **MORE** to display the second programming submenu screen.
3. Press **PRIV** to display the configuration screen.
The current selection is displayed in the second row.
4. Select the desired option:
 - Press **YES** when waiting for a second tone is required. In this case, configure the delay using the **WAIT** parameter (para. 2-4.2.5).
 - Press **NO** when no waiting is required.

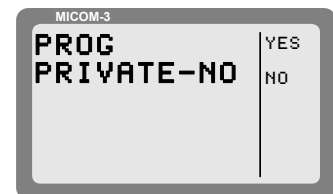

NOTE

If you are required to dial only one digit and a second dial tone is supplied immediately, the **PRIV** parameter must be set to **NO**. This parameter should be set to **YES** only in installations where there is a delay between the dialing of the first digit and the reception of a dial tone.

5. Press **ENTER** to confirm your selection.

2-4.2.5 Wait Time

When the **PRIV** parameter is **YES**, the MICOM TEL will wait for a dial tone before dialing the other digits of the phone number. The **WAIT** parameter defines the interval (in seconds) to wait before the other digits of the phone number is dialed. However, if a dial tone is received before this interval expires, the MICOM TEL will begin dialing immediately.

The supported range is 1 to 30 seconds. The MICOM TEL will dial the access digit, wait for the dial tone or for the wait time to expire, and will then dial the rest of the telephone number.

To program the wait time:

1. Access the MICOM TEL programming submenu using **MENU > MORE > MORE > UTIL > ASTC > PROG.**

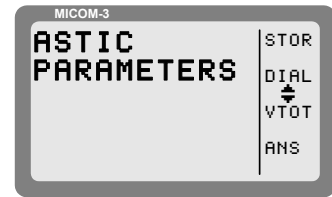

2. Press **MORE** to display the second programming submenu screen.

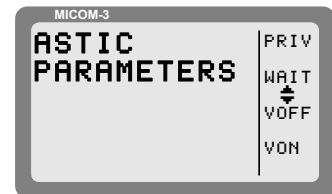

3. Press **WAIT** to display the wait time selection screen. The current selection is displayed in the second row.

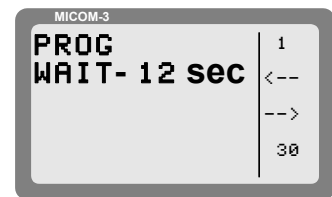

4. Select the desired interval:
 - Press **1** to set the **WAIT** time to 1 second.
 - Press **30** to set the **WAIT** time to 30 seconds.
 - Use **<--** or **-->** to scroll within the supported range, 1 to 30 seconds.
5. Press **ENTER** to confirm your selection.

2-4.2.6 VOX Activation and Deactivation Thresholds

As mentioned in para. 2-4.2.2, MICOM TEL uses a VOX circuit to detect voice activity on the phone line, and generate a PTT signal for the transceiver.

For best results, it is necessary to adjust the sensitivity of the VOX, that is, the relative levels at which the VOX is activated (starts generating a PTT signal) or deactivated (stops generating the PTT signal) in accordance with phone line quality.

The optimum threshold values depend on the line quality, as follows:

- The VOX activation threshold (VOX ON) must be high enough to ensure that noise on the line is not erroneously identified as voice, but low enough to generate PTT when the phone subscriber speaks at normal volume:
 - Setting a high activation level will force the phone subscriber to raise his/her voice to key the transceiver.
 - If the VOX ON value is too low in relation to line quality, this could cause false activation of the VOX.
- The VOX deactivation threshold (VOX OFF) must be high enough to ensure that noise on the line does not keep the transceiver keyed after the phone subscriber stops speaking, yet it must always be lower than the activation threshold.
 - If the VOX OFF value is too low in relation to line quality, this could prevent the transceiver from returning to the receive mode after the phone subscriber stops speaking.
 - If the VOX OFF value is too high, the phone subscriber will have to speak loudly in order to maintain the transceiver in the transmit mode.

The relative levels are selected on a scale of 0 to 10. Recommended values, which work on most lines, are VOX ON = 7 and VOX OFF = 6.

To program the VOX deactivation threshold:

1. Access the MICOM TEL programming submenu using **MENU > MORE > MORE > UTIL > ASTC > PROG**.
2. Press **MORE** to display the second submenu screen.
3. Press **VOFF** to display the VOX deactivation threshold. The current selection is displayed in the second row.
4. Select the desired value:
 - Press **0** (the F1 key) to set the VOX deactivation threshold to 0.
 - Press the F4 key to set the VOX deactivation threshold to its maximum value (the value selected for the activation threshold).
 - Use **<--** or **-->** to scroll within the allowed range of values (0 to the VOX ON value).
5. Press **ENTER** to confirm your selection.

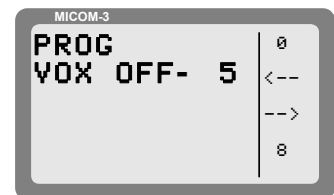
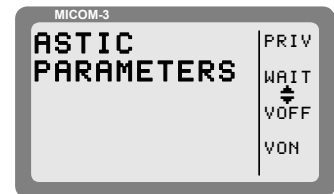
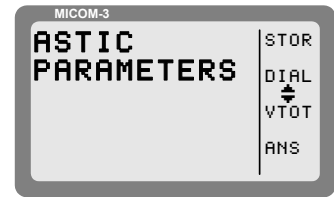
**To program the VOX activation threshold:**

1. Access the MICOM TEL programming submenu using **MENU > MORE > MORE > UTIL > ASTC > PROG**.
2. Press **MORE** to display the second submenu screen.
3. Press **VON** to display the VOX activation threshold selection screen. The current selection is displayed in the second row.
4. Select the desired threshold:
 - Press **0** to set the VOX activation threshold to 0.
 - Press **10** to set the VOX activation threshold to 10.
 - Use **<--** or **-->** to scroll within the range of the VOX activation threshold values, 1 to 10.
5. Press **ENTER** to confirm your selection.

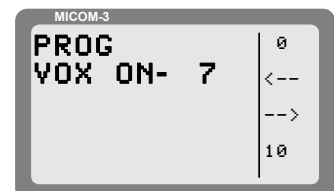
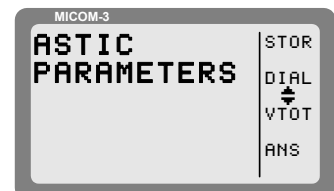

2-4.3 Storing MICOM TEL Parameters

After finishing the configuration tasks, the MICOM TEL parameters must be programmed (stored) into the MICOM TEL.

To store MICOM TEL parameters:

1. Access the MICOM TEL programming submenu using **MENU > MORE > MORE > UTIL > ASTC > PROG.**



2. Press **STOR** to save the MICOM TEL parameters. The process is started, and you see its progress.



3. After programming is completed, you will see the result:
 - The message **PROG – O.K.** indicates that programming has been successfully completed.
 - The message **PROG FAILED** indicates that the programming process failed. Turn the MICOM TEL and the transceiver off, and then back on, and repeat the configuration process: if it fails again, request servicing.

2-4.4 Configuring MICOM TEL Aliases

To set up a link from a phone subscriber to a remote user over the HF-SSB link, it is necessary to specify the ALE address of the transceiver serving the remote user.

In most cases, a remote phone subscriber cannot dial directly the ALE address, which it is 15-digit long and can include alphanumeric characters.

To solve the problem, MICOM TEL can be programmed to recognize aliases for the desired ALE addresses. An alias comprises up to three digits. The phone subscriber then dials the alias to set up a phone call to the desired destination.

To configure aliases:

1. Access the ASTC submenu using **MENU > MORE > MORE > UTIL > ASTC.**

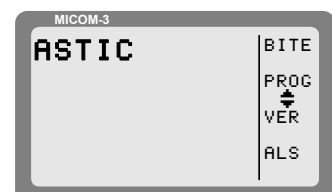

2. Press **ALS** to display the alias programming screen. If no aliases have been configured, you will see **empty**, otherwise you see the first alias.

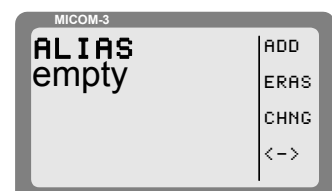

3. To add a new alias, press **ADD**.

4. You will see the first entry in the ALE directory. If necessary, scroll using the UP/DOWN keys to select another destination, and then press **EDIT** to configure the alias.

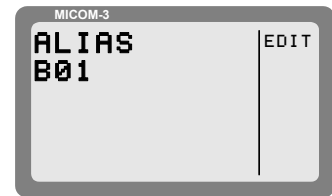

5. Select the three digits of the alias. Make sure the alias is unique.

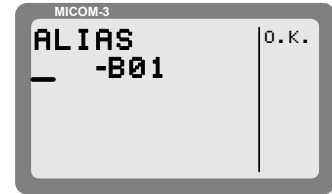

6. When done, press **OK** to confirm and return to the ALIAS screen.

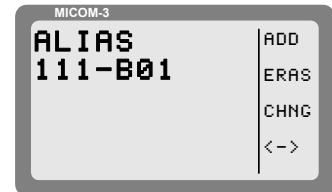

7. Repeat the process to define the other necessary aliases.

You can also delete an existing alias by selecting **ERAS**, or change it by pressing **CHNG**: to select an alias from the list, press the **SCROLL** (<->) or use the **UP/DOWN** keys.

2-4.5 Stopping MICOM TEL Operation

If you do not intend to continue using the MICOM TEL, disconnect its power by separating the extension cable plug from the red lead of the DC power cable.

Intentionally Left Blank

CHAPTER 3

MAKING CALLS

3-1. SCOPE

This Chapter provides detailed instructions for using MICOM TEL to make calls over HF-SSB radio links operating in the ALE mode.

Three typical application scenarios are presented:

- Calling a radio user from a phone – para. 3-3.
- Calling a phone subscriber from a radio set – para. 3-4.
- Phone subscriber calling another phone subscriber over a radio link – para. 3-5.

Para. 3-2 provides general information and considerations regarding the use of MICOM TEL.

3-2. GENERAL INFORMATION

3-2.1 General Procedures

1. MICOM TEL provides an interface that emulates a standard phone set toward the phone line, it transfers the phone traffic over a half-duplex radio link. Therefore, always wait for the other party to finish speaking before answering.

Since the MICOM TEL uses a VOX circuit to detect voice activity on the phone line and key the radio set, it will let you know that you can start speaking by providing a short beep. This beep indicates that the phone subscriber stopped speaking, and the VOX circuit switched the remote radio set to the receive mode, so it is ready to hear you.

2. MICOM TEL is assigned a directory number in the phone network, as any regular phone. As a result, the number to be dialed by the phone subscriber consists of two parts:
 - The phone number needed to call the MICOM TEL. After dialing this number, wait for the MICOM TEL to pick up the call.
 - The alias of the remote destination (three digits), which is dialed after the MICOM TEL picks up the call. After the dialed string, always press # to instruct the MICOM TEL to start processing the call.

NOTE

Make sure to obtain the list of aliases you will need from your system administrator.

When dialing, do not stop for more than 30 seconds between digits: if you stop dialing for more than 30 seconds, the call is aborted.

3. To disconnect a call, dial # on the phone. The radio user can also disconnect the call by pressing ESC to disconnect the ALE link (the radio then starts scanning again).

NOTE

Since # is used as a control character, it cannot be dialed by the phone subscriber for any other purpose (some automated phone call answering systems may require you to dial # for other purposes).

The call is also automatically disconnected if no activity is detected for a certain time (determined by the VTOT parameter – see Chapter 2).

3-2.2 Monitoring the Call

You can monitor the call processing by means of the visual indications provided by the MICOM TEL and the radio set. In addition, you can also hear auditory indications (beeps) which indicate the call status.

3-2.2.1 Visual Indications

You can use the LINE indicator on the MICOM TEL front panel to detect whether MICOM TEL is engaged in a call. This indicator turns on when a call request is received from the PABX or PSTN line, and also when a call destined to a phone subscriber is received over the radio, and will continue to light until the call is disconnected.

The radio set display can also be used to monitor the progress of the call.

- When a valid call is received from the PABX or PSTN line (that is, when the LINE indicator turns on), the radio stops scanning and starts setting up the ALE link to the requested destination.
- When a call to a phone subscriber is received over the radio, you see the ALE link connected. After the link is connected, the LINE indicator turns on, as the MICOM TEL connects to the phone line (goes off-hook) and dials to set up the call to the requested phone number.
- When the call is over, the radio set returns to the ALE scan mode, and the LINE indicator turns off.

3-2.2.2 Auditory Indications

The progress of a call can be monitored by means of the tones generated by the MICOM TEL. Note however that dial and ringback tones are generated by the PABX or PSTN to which MICOM TEL is connected. The following are generated by MICOM TEL:

- Wait tone – is generated after dialing is completed, and the setting up of the ALE link to the destination is in progress.
- After the ALE link is set-up, a faster wait tone is generated, until the radio user answers by pressing the PTT.
- Error tone – is generated after dialing is completed, and the ALE destination is invalid. The same tone is used to indicate automatic disconnection.
- If the destination is busy, you will hear the busy tone.

Table 3-1. Signaling Tone Description

Tone	Frequency	Cadence
Busy	480 Hz	On – 0.5 sec
	620 Hz	Off – 0.5 sec
Wait	450 Hz	On – 1.0 sec
		Off – 3.0 sec
Fast Wait	500 Hz	On – 0.6 sec
		Off – 2.0 sec
Error and Disconnect	300 Hz	On – 0.3 sec
	400 Hz	Off – 0.3 sec

3-3. CALLING A RADIO USER FROM A PHONE

A MICOM TEL connected to a MICOM-3 radio set in a base station permits any phone to call any radio set in the ALE net of the MICOM-3 radio set. A MICOM TEL is needed at the base station radio, but not at the destination radio set.

To make this type of call, the phone subscriber needs the following information:

- The phone number assigned to MICOM TEL.
- The alias assigned to the destination.

To call the desired remote radio user:

1. Pick-up the phone handset. When you hear the dial tone, dial the MICOM TEL telephone number. You should hear a ringback tone.
If a busy tone is heard, go on-hook and try again later.
2. If the line is not busy, after several rings the MICOM TEL answers and you will hear a sequence of beeps.
3. After the beeps, dial the destination radio alias, terminating with # (for example, if the alias is **111**, dial **111#**).
4. After dialing is completed, MICOM TEL checks that the dialed alias is valid (that is, corresponds to an ALE destination address programmed in the radio connected to the MICOM TEL).
 - If the address is valid, the MICOM-3 radio set starts the ALE link setup process:

When the process is started, you see the CALL station screen.

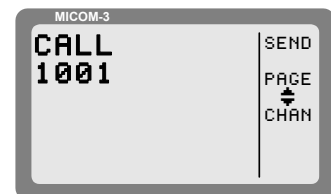

After a channel is selected, you see the selected channel screen.

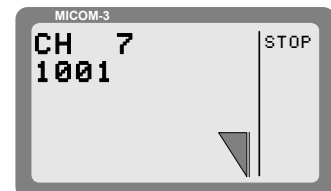

During the link setup process, wait tone (beeps) are heard (the wait tone is described in Table 3-1). The wait beeps continue until the ALE link is established.

- If the address is not valid, an error (chirp) tone will be heard (see description in Table 3-1). Try dialing again the alias (Step 3 above).
- If the radio connected to the MICOM TEL is busy, a busy tone will be heard and MICOM TEL disconnects. Try again later.

If the ALE link cannot be established, the disconnect tone is heard. Try again later.

5. After the ALE link is established, you will hear the fast wait tone (see description in Table 3-1) until the radio user answers. At this time, you can start the conversation. Speak in a loud and clear voice.

NOTE

Before answering, the remote radio user must wait for a beep after the phone subscriber finished talking.

6. Either party can end the call, using one of the following ways:

- The phone subscriber presses the # key.
- The remote radio user disconnects the ALE link by pressing **ESC**.

The call is also automatically ended after the phone subscriber does not speak for the duration set by the VTOT parameter (VOX time-out timer).

3-4. CALLING A PHONE NUMBER FROM A REMOTE RADIO

Any MICOM-3 radio in an ALE net that can communicate with a base station equipped with MICOM TEL can call any phone line connected to the MICOM TEL. A MICOM TEL is needed at the destination base station, but not at the calling radio set.

To make this type of call, the MICOM-3 radio user needs the following information:

- The ALE address of the base station.
- The number to be dialed to reach the destination phone.

NOTE

The phone number is sent to the base station as an AMD message using the PAGE function. The message must include the string **DIAL** followed by the digits to be dialed. When frequent calls are made to a given destination, it is convenient to save the AMD message.

To initiate the call at the radio set:

1. Check that the radio ALE status is scanning.
2. Initiate the call to the base station: press **CALL** and then select the desired ALE address (for example, B01) using the UP/DOWN keys.
3. To enter the desired telephone number, press **PAGE**: you may edit a new message, or select a predefined dialing message by scrolling through the existing messages.

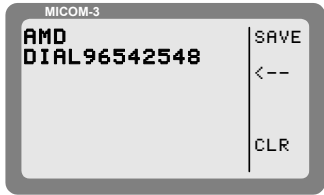
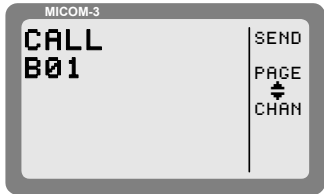
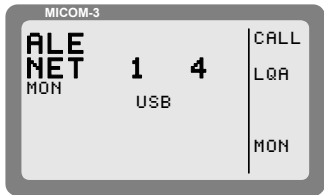

If you decide to edit a message, press **EDIT**. The message must include the telephone number, preceded by the string **DIAL**:

- To save this message in one of the predefined messages, press **SAVE**.
 - To send without saving the message, press **ENTER**.
4. When ready to send the dialing message, press **SEND**. The ALE link set up process is started, and you can monitor its progress on the MICOM-3 display.
 5. When the ALE link is established, the display shows **LINK** and the called station.
 6. After a few seconds, the radio user hears the phone call tones being processed at the receiving end (the base station): first the dial tone, then ringback or busy.

In case of a busy tone, MICOM TEL will automatically disconnect the line. Try again later.

7. If the ringback tone is heard, wait until the phone subscriber answers and then start the conversation. Speak in a loud, clear voice.
8. Either party can end the call, using one of the following ways:
 - The phone subscriber presses the # key.
 - The remote radio user disconnects the ALE link by pressing **ESC**.

The call is also automatically ended after the phone subscriber does not speak for the duration set by the VTOT parameter (VOX time out timer).

3-5. CALL BETWEEN PHONE SUBSCRIBERS OVER RADIO LINK

MICOM-3 radio sets equipped with MICOM TEL which are members in the same ALE net enable setting up phone calls over HF-SSB links.

To make this type of call, the calling phone subscriber needs the following information:

- The phone number assigned to the local MICOM TEL.
- The alias assigned to the destination radio set.
- The number to be dialed to reach the destination phone from the remote unit.

To call the desired remote phone:

1. Pick-up the phone handset. When you hear the dial tone, dial the local MICOM TEL telephone number. You should hear a ringback tone.

If a busy tone is heard, go on-hook and try again later.

2. If the line is not busy, after several rings the MICOM TEL answers and you will hear a sequence of beeps.
3. After the beeps, dial the following sequence:
 - The destination radio alias.
 - An asterisk *
 - The called phone number, terminating with #.

For example, if the alias is **111** and the called number is **96542548**, dial **111*96542548#**.

Do not stop for more than 30 seconds during dialing.

4. After dialing is completed, the local MICOM TEL checks that the dialed alias is valid (that is, corresponds to an ALE destination address programmed in the radio connected to the MICOM TEL).
 - If the address is valid, the MICOM-3 radio set starts the ALE link setup process: first you see the CALL station screen, and then the selected channel screen.

During the link setup process, wait tone (beeps) are heard (the wait tone described in Table 3-1). The wait beeps continue until the radio link to the destination radio is established.

 - If the address is not valid, an error (chirp) tone will be heard. Try dialing again (Step 3 above).
 - If the radio connected to the MICOM TEL is busy, a busy tone will be heard and MICOM TEL disconnects. Try again later.

If the ALE link cannot be established, the disconnect tone is heard. Try again later.

5. After the ALE link is established, you can start the conversation. Speak in a load and clear voice.

NOTE

Before answering, wait for a beep after the other phone subscriber finished talking.

6. Either party can end the call, using one of the following ways:

- The phone subscriber presses the # key.
- The remote radio user disconnects the ALE link by pressing **ESC**.

The call is also automatically ended after the phone subscriber does not speak for the duration set by the VTOT parameter (VOX time out timer).

CHAPTER 4

OPERATOR MAINTENANCE

4-1. SCOPE

Operator maintenance consists of routine tasks and specific checks and services that are needed to keep MICOM TEL in a “ready to use” condition, and therefore should be carried out together with the transceiver operator maintenance (covered by the transceiver Owner’s Guide).

Routine tasks such as cleaning, checking cables for damage, checking for loose bolts, nuts and screws, must be performed whenever the operator sees that they are necessary and therefore, are not listed in the following tables.

WARNING

Operating and maintenance personnel must be familiar with all the applicable safety requirements before attempting to operate and maintain the radio set, and the MICOM TEL. See the beginning of this manual for safety precautions.

If a problem is suspected, refer to para. 4-3.

4-2. PREVENTATIVE MAINTENANCE

Periodically check the integrity of your system, by inspecting the equipment for damage, and loose or missing parts or screws. Also remove dust and dirt with a dry brush or soft cloth.

4-3. CORRECTIVE MAINTENANCE

The scope of corrective maintenance at the operator level is to return the system to normal operation as soon as possible, by replacing cables, accessories, or equipment units suspected of being defective. Contact your service representative for additional help.

In case a fault is detected, or the radio set fails to operate, first perform the troubleshooting steps related to the radio set, in accordance with its Owner's Guide.

If the problem persists, troubleshoot the MICOM TEL by performing the following steps until the problem is corrected:

1. Visually inspect the MICOM TEL, its connections to the radio set and to the phone line, and make sure that they are assembled properly and ready for operation.

Check that the radio set can transmit and receive normally. If not, turn the radio set off and then back on, and monitor the display: every time the radio is turned on, a self-test procedure is performed and if an internal malfunction is found, an error message will be displayed. Refer to the Maintenance section of the “MICOM-3F/3T/3R HF-SSB Transceivers Owner’s Guide”, Publication 6886867J01, for a description of the error messages, and the recommended actions.

2. If the radio set operates normally, disconnect the phone line from the MICOM TEL and connect it to a regular phone set. Now check that you can make and receive phone calls using the phone: if not, the phone line must be checked.

If you can make and receive calls, reconnect the line to the MICOM TEL LINE connector.

3. Check that the fuse of the MICOM TEL power cable is OK. If not, replace it with a 5A/32V fuse of the same type as that installed in the fuse housing. Also check that the DC power cable is properly connected, and that the DC source provides the correct voltage (13.8 VDC nominal).
4. Using the transceiver front panel, initiate MICOM TEL self-test as follows:

- Press **MENU > MORE > MORE > UTIL > ASTC** to enter the ASTC submenu.

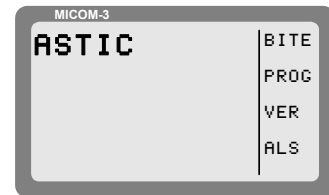

- Press **BITE** to run the MICOM TEL self-test.
While the self-test is in progress, **BITE...** is displayed, followed by a number of periods that indicates the progress of the test.



- If the test is successfully passed, you will see **PASS**.

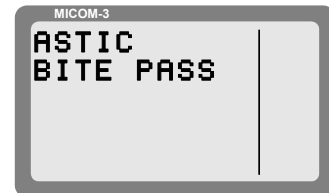

- If a MICOM TEL malfunction is detected, the error number is displayed in the first line of the display, and a short description of the error appears in the second line. Press the **UP/DOWN** keys to see if there are additional error messages.
If an error is reported, MICOM TEL must be serviced. Contact your service representative.
- Press **EXIT** to exit.

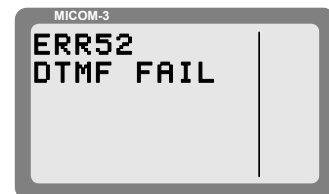

4-4. DISPLAYING THE MICOM TEL HARDWARE AND SOFTWARE VERSIONS

The MICOM TEL software and hardware versions can be read through the radio.

NOTE
The versions shows below are for illustration only. The versions displayed by your MICOM TEL may be different.

To display the MICOM TEL version:

1. Press **MENU > MORE > MORE > UTIL > ASTC** to display the ASTC submenu.

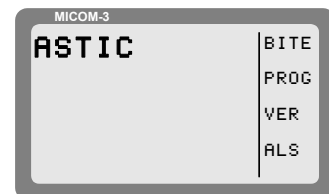

2. Press **VER** to display the version selection screen.

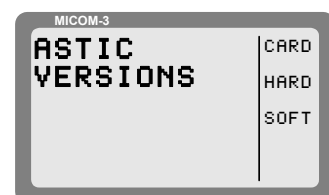

3. Press **CARD** to view the card type.

The only option is now **PABX**, which means that the MICOM TEL is intended for connection to a PABX or PSTN line.



4. Press **HARD** to display the hardware version number.

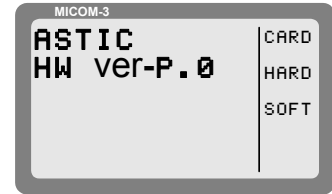

5. Press **SOFT** to display software version number.

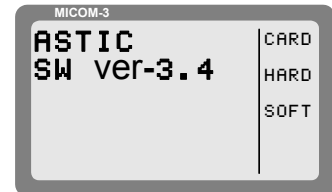

Intentionally Left Blank